

## **PROTOCOLS FOR SYNCHRONIZATION OF ESTRUS AND OVULATION**

S.K. Johnson<sup>1</sup>, R.N. Funston<sup>2</sup>, J.B. Hall<sup>3</sup>, G.C. Lamb<sup>4</sup>, J.W. Lauderdale<sup>5</sup>,  
D.J. Patterson<sup>6</sup>, and G.A. Perry<sup>7</sup>

<sup>1</sup>Department of Animal Sciences and Industry, Kansas State University, Colby, KS

<sup>2</sup>West Central Research and Extension Center, University of Nebraska, North Platte, NE

<sup>3</sup>Department of Animal & Veterinary Sciences, University of Idaho, Carmen, ID

<sup>4</sup>North Florida Research and Education Center, University of Florida, Marianna, FL

<sup>5</sup>Department of Animal Science, Michigan State University, Kalamazoo, MI

<sup>6</sup>Division of Animal Sciences, University of Missouri, Columbia, MO

<sup>7</sup>Department of Animal and Range Sciences, South Dakota State University, Brookings, SD

### **Introduction**

The potential for genetic improvement in beef herds in the US through advances in biotechnology has never been greater. Recent improvements in our understanding of methods of inducing and synchronizing estrus and ovulation in postpartum beef cows and replacement beef heifers creates the opportunity to significantly expand the use of artificial insemination in both purebred and commercial herds. Technology now exists to successfully inseminate beef cows at predetermined fixed times with pregnancy rates comparable to those achieved detecting heat.

While many options exist for synchronization of estrus and ovulation, this short list of protocols was developed based on available research data and field use by the Beef Cattle Reproduction Leadership Team. This group is composed of representatives from the AI and pharmaceutical industries, veterinarians, and reproductive physiologists from the Beef Reproduction Task Force with active research programs in this area.

### **Selecting a Synchronization Protocol**

Each producer should evaluate available resources and assess the cows or heifers intended for synchronization before selecting a protocol. Key considerations should include time and skill available for heat detection, body condition of the cows or heifers, days postpartum in cows, facilities, experience, and cost.

*Amount of heat detection.* The first step in selecting a synchronization protocol is to determine how much, if any, heat detection is feasible or desired. Some management systems make heat detection and the sorting of animals very simple and effective. In other cases, heat detection can be very difficult. Poor detection efficiency can result in a low AI pregnancy rate. The recommended protocols are divided into three groups based on amount of heat detection required; 1) heat detection for 7 to 8 days, 2) heat detection for 3 days followed by fixed-time AI of all remaining animals not previously detected in heat (clean-up timed AI) or 3) strict fixed-time AI.

*Cow factors.* Any of the synchronization protocols are recommended for mature cows with a body condition score of 5 or greater that are 50 days or more since calving at the time of AI. Young, thin, and late calving cows are all less likely to have resumed their estrous cycles at the beginning of the breeding season. If a high percentage of cattle are in these categories, consideration should be given to protocols that include a progestin such as a CIDR. The progestin will induce some non-cycling cows to cycle and improve their chance of conceiving to AI. If cows are too thin or have calved too recently, the investment in synchronization of estrus may not be cost effective.

*Heifer factors.* Age and weight are key factors that influence time of puberty in heifers. Heifers should attain 60% of their mature weight prior to breeding. Because selection pressure on growth has increased mature cow size, producers may tend to underestimate future mature size. Producers that score heifer reproductive tracts at 50 to 60 days prior to breeding have a true measure of physiological maturity and time to adjust rations prior to breeding. If 50% of heifers have a tract score of 3 or greater 50 to 60 days prior to breeding, estrous synchronization programs tend to be more successful. Protocols including a progestin such as MGA or CIDR will induce some prepubertal heifers to cycle.

*Other.* Length of the protocol, number of times handled, and the ability to successfully deliver treatments, such as MGA are other factors that must be considered when choosing a synchronization protocol. Management system, feed resource flexibility, and facilities will play a role in which protocol works best in each particular environment. Success of any protocol is dependent on the proper administration and timing of treatments. For help see the Estrus Synchronization Planner at [http://www.iowabeefcenter.org/estrus\\_synch.html](http://www.iowabeefcenter.org/estrus_synch.html). The planner develops a calendar for application of protocols and can compare costs of up to three protocols.

*Cost.* If labor is available or can be hired, protocols using heat detection are generally lower cost than fixed-timed AI. Treatments, semen and number of handlings will contribute to cash costs of synchronization. Estimated savings from fewer bulls needed for natural service and increased returns from age and weight of AI sired calves should be considered. Producers that find AI most cost effective are those that capture additional returns from AI sired calves.

*Which animals should I synchronize?* When starting an AI program for the first time, replacement heifers probably are the easiest group of animals to work with and first calf heifers the most difficult group to achieve success. Start simple and add more animals as you gain experience.

## **Products Used**

Hormones common to many protocols are prostaglandin F<sub>2α</sub> (**PG**), gonadotropin releasing hormone (**GnRH**) and progestins. They are available in the following commercial products (Table 1).

**Table 1.** Estrus synchronization products and commercial names.<sup>1</sup>

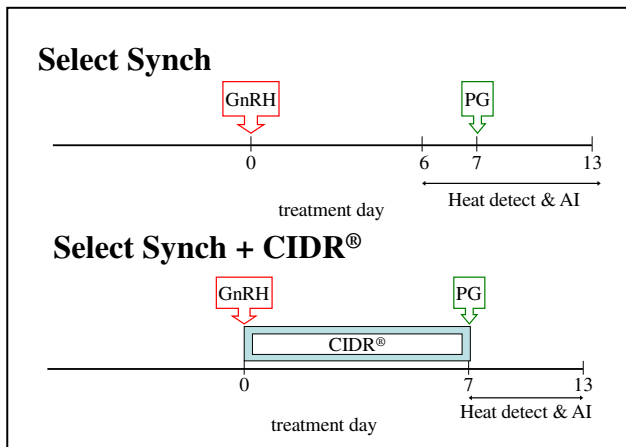
Type	Commercial name
GnRH	Cystorelin <sup>®</sup> , Factrel <sup>®</sup> , Fertagyl <sup>®</sup> , OvaCyst <sup>®</sup>
PG	estroPLAN <sup>®</sup> , Estrumate <sup>®</sup> , In-Synch <sup>®</sup> , Lutalyse <sup>®</sup> , ProstaMate <sup>®</sup>
Progestin	MGA <sup>®</sup> (melengesterol acetate), CIDR <sup>®</sup> (progesterone)

<sup>1</sup>Follow label directions for dose and route of administration.

## Protocols

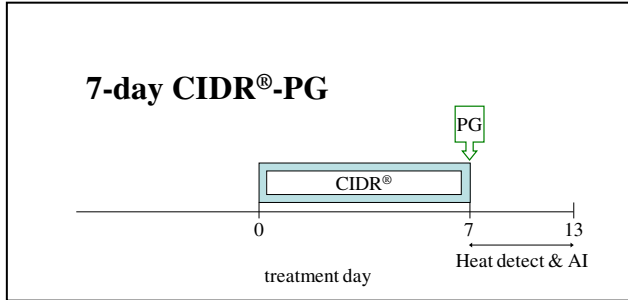
**Heat detection protocols.** Animals in these protocols should be inseminated 6 to 12 hours after the first observation of standing heat. During peak activity (48 to 72 hours after PG for most systems), heat detection for a total of three hours per day at three or more times would be a minimum and a total of 5 to 6 hours better.

Protocols for use in cows include **Select Synch** and **Select Synch + CIDR<sup>®</sup>** (Figure 1). Including the CIDR is recommended when more cows are likely to be anestrus and/or when heat detection prior to PG is not feasible. With Select Synch, 5 to 20% of the animals may show heat 1.5 to 2 days before PG. Both protocols could be applied to the same group of cows, with CIDRs selectively placed in young, thin, and/or late calving cows.



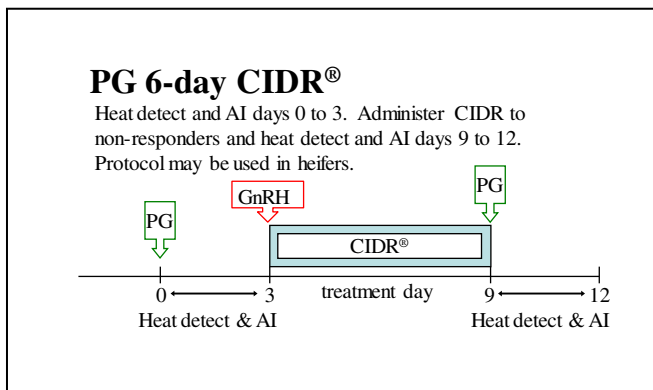
**Figure 1.** Heat detection only protocols for cows; Select Synch and Select Synch + CIDR.

The **7-day CIDR<sup>®</sup>-PG** protocol (Figure 2) is recommended in heifers in contrast to the Select Synch + CIDR<sup>®</sup> protocol in cows. The difference is that heifers do not require the GnRH injection at the beginning of the treatment. Research has shown pregnancy rates from the 7-day CIDR<sup>®</sup>-PG protocol similar to those from the Select Synch + CIDR<sup>®</sup> protocol in heifers. Select Synch is not preferred for heifers because a wider range in responses to Select Synch has been reported in heifers perhaps due to inconsistent response to GnRH.



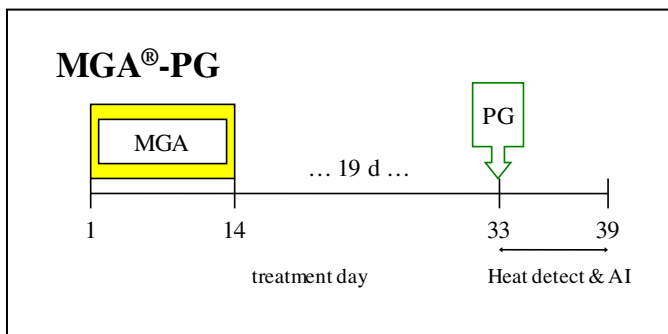
**Figure 2.** Heat detection only protocol for heifers, 7-day CIDR-PG.

A new heat detection option is the **PG 6-day CIDR®** protocol (Figure 3). The protocol reduces treatment costs for any cows inseminated after the first PG. More days of heat detection are required and supplies of synchronization products would need to be on hand for all cows or readily available. This protocol could be used on cows or heifers.



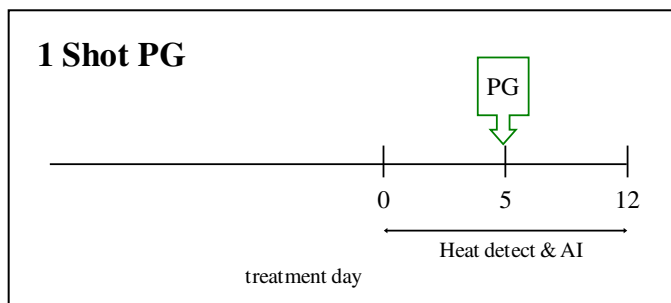
**Figure 3.** Heat detection only protocol; PG 6-day CIDR.

Feeding of MGA is specifically approved for estrus suppression in heifers only. The MGA-based protocol recommended for heifers is **MGA®-PG** (Figure 4). More advance planning is needed as this protocol begins with feeding MGA for 14 days starting 33 days before injection of PG. If MGA can be delivered accurately on a daily basis; this is a very effective protocol in beef heifers. The original recommendation for the interval between the last feeding of MGA and PG injection was 17 days. Delaying this interval to 19 days improves synchrony of estrus.



**Figure 4.** Heat detection only protocol for heifers, MGA-PG.

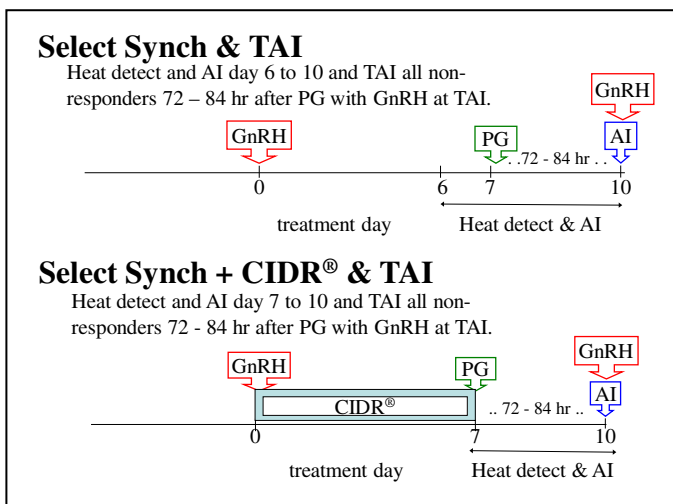
A single injection of PG (Figure 5) can be used on heifers. This protocol does not provide the degree of synchrony compared to other protocols and the heat detection period is twice as long. Nevertheless, it is a low cost method that often works well for those just starting to use AI. It could be used on cows, but because sorting and heat detection are more complex when the calf is present, other options should be considered more carefully. Heifers that have not reached puberty or cows that have not initiated estrous cycles do not have a corpus luteum (CL) and **will not** respond to this treatment. Heifers observed in heat and inseminated before the time of PG injection do not require PG.



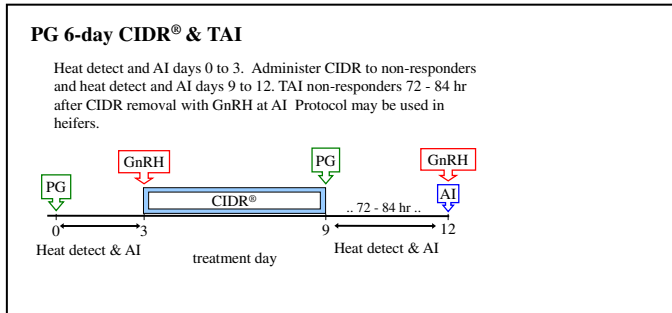
**Figure 5.** Heat detection only protocol for heifers, single shot PG.

**Heat detection & timed AI (TAI) protocols.** Heat detection and timed AI protocols involve AI 6 to 12 hours after observed estrus for 3 days then timed AI of all non-responders 72 to 84 hours after PG with GnRH given at TAI. The amount of time spent on heat detection is reduced and early responders have a better chance of conceiving compared to a single fixed-timed AI.

The same protocols recommended for heat detection are also recommended for the combination of heat detection and timed AI in cows (Figures 6 & 7). The success of these protocols is still dependent on good heat detection, particularly for early heats in the Select Synch protocol.

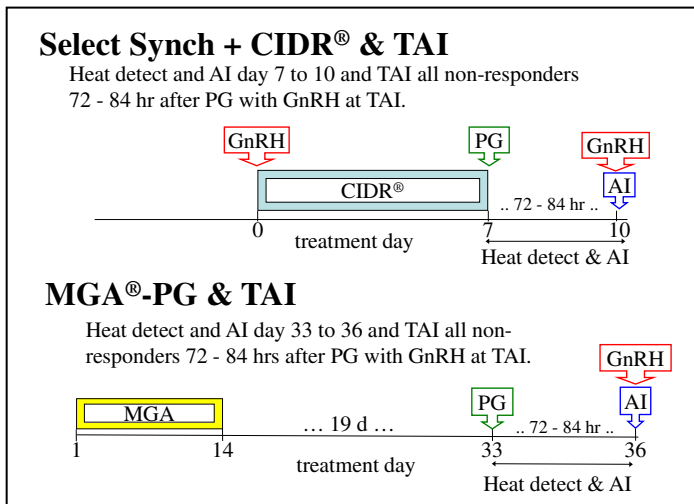


**Figure 6.** Heat detection and clean-up timed AI protocols for cows, Select Synch & TAI and Select Synch + CIDR & TAI.



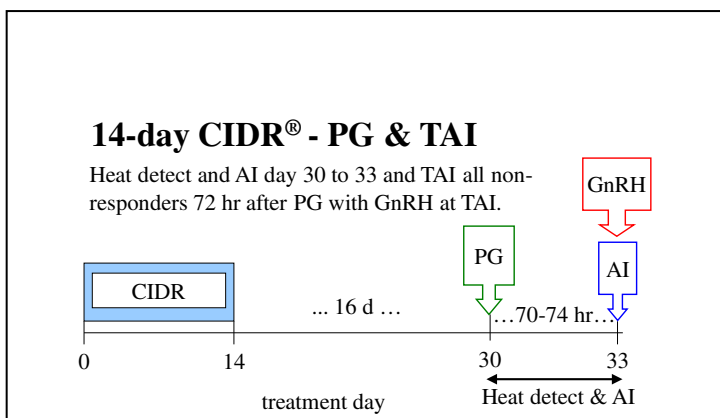
**Figure 7.** Heat detection and clean-up timed AI protocol for cows, PG 6-day CIDR & TAI.

In heifers, the MGA®-PG (Figure 8) protocol can be used combining heat detection and timed AI. A second protocol recommended for use in heifers is Select Synch + CIDR® (Figure 8). GnRH is recommended on day 0 in this protocol as it adds little additional cost and heifers that do respond with a new follicular wave are more likely to conceive at the clean-up timed AI.



**Figure 8.** Heat detection and clean-up timed AI protocols for heifers, Select Synch + CIDR & TAI and MGA-PG & TAI.

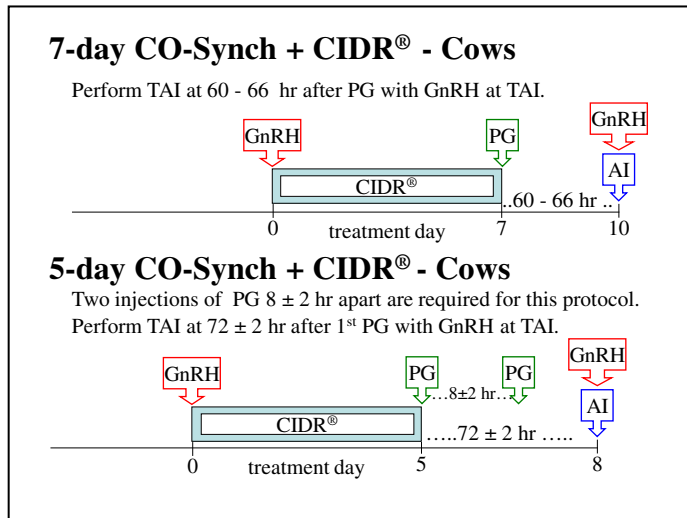
The third option for combination heat detection and TAI in heifers is **14-day CIDR® - PG** (Figure 9). This protocol appears similar to MGA-PG but the interval between CIDR removal and PG is reduced to 16 days. This is because the progesterone in CIDR treated animals is cleared from the body much faster than melengesterol acetate in MGA-treated animals.



**Figure 9.** Heat detection and timed AI protocols for heifers, 14-day CIDR-PG & TAI.

**Fixed-time AI protocols.** With fixed-time AI protocols, all animals are inseminated at a predetermined time. For cows, fixed-timed AI can produce similar pregnancy rates as protocols that require 5 to 7 days of heat detection. For heifers, pregnancy rates from current TAI protocols tend to be 5 to 10% lower than using heat detection alone (the exception may be the 14-day CIDR-PG). The times listed for fixed-time AI should be considered as the approximate average time of insemination. This should be based on the number of females to inseminate, labor and facilities.

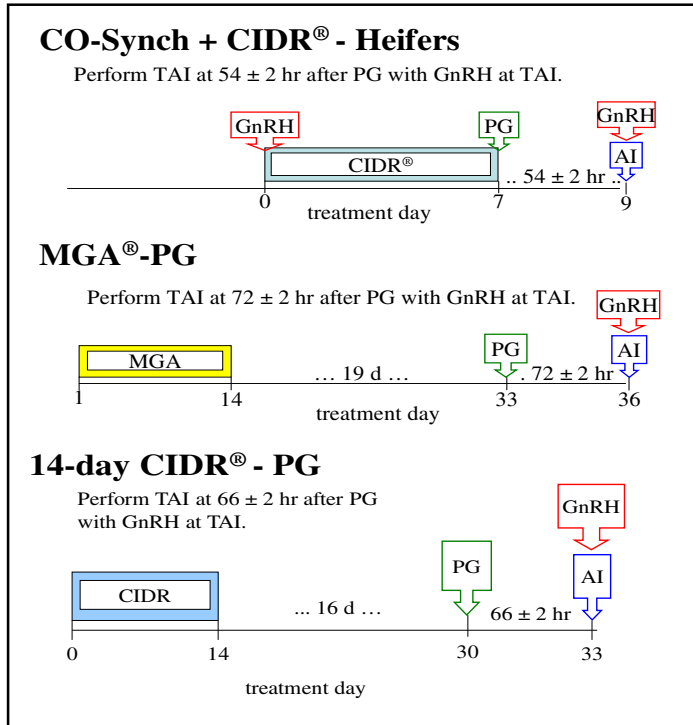
The **7-day CO-Synch + CIDR<sup>®</sup>** protocol is recommended for both cows (Figure 10) and heifers (Figure 11). Cows should be inseminated between 60 and 66 hours after CIDR removal. Insemination time for heifers is recommended at 52 to 56 hours after CIDR removal. A shortened **5-day CO-Synch + CIDR<sup>®</sup>** protocol (Figure 10) is another option for cows. Two full doses of PG given 8 hours apart are critical for success in the shortened protocol.



**Figure 10.** Fixed-time AI protocols for cows, 7-day CO-Synch + CIDR and 5-day CO-Synch + CIDR.

**MGA<sup>®</sup>-PG** (Figure 11) can be used with fixed-time AI in heifers; however, pregnancy rates will likely be lower than with the CO-Synch + CIDR<sup>®</sup> protocol or the 14-day CIDR<sup>®</sup>-PG protocol. For many producers a CIDR-based protocol would be lower risk for fixed-time AI than MGA<sup>®</sup>-PG as they are not reliant on accurate, daily MGA consumption and control of follicular growth should be better.

The 14-day CIDR<sup>®</sup>-PG (Figure 11) protocol is the most recently developed fixed-time AI protocol for heifers. It is 3 days shorter than MGA<sup>®</sup>-PG and requires one more handling than CO-Synch + CIDR.



**Figure 11.** Fixed-time AI protocols for heifers, CO-Synch + CIDR, MGA-PG and 14-day CIDR-PG.

### Summary

Considerable research and field data support the use of these protocols as described. Other protocols should only be considered in unique situations and with the advice of someone with extensive experience with estrus synchronization protocols. Alterations of any protocol should be supported with sound research data.